

Pablo®

# CORTINA

24, 48, 60, 72 ASSEMBLY & INSTALLATION INSTRUCTIONS



APPROVED COMPONENTS

# Pablo®

# CORTINA

## CORTINA MODELS

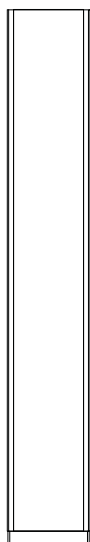

CORTINA 72

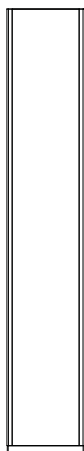

CORTINA 60

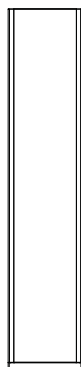

CORTINA 48



CORTINA 24

## BULB TYPE

CORTINA 24, 48, 60: 2X E27 / 60W-PAR16 NSP BULB  
CORTINA 72: 2X E27 / 75W-PAR16 NSP BULB



## ASSEMBLY

- 1 REMOVE PARTS FROM PACKAGING.  
BULBS ARE LOCATED INSIDE SHADE

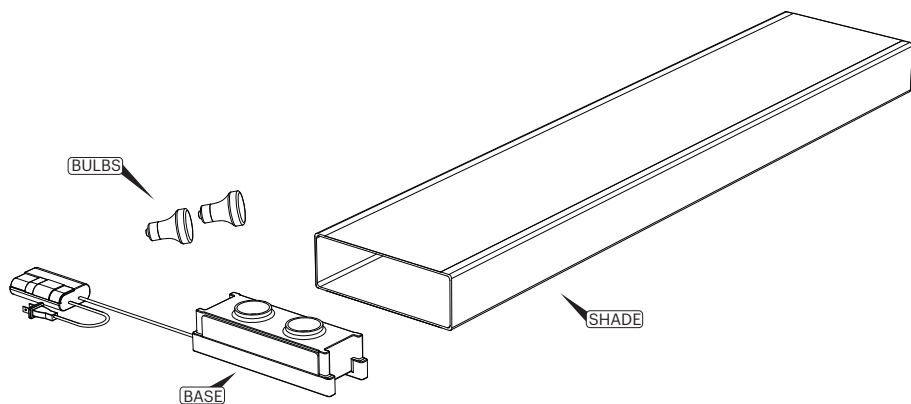

# Pablo®

# CORTINA

---

## ASSEMBLY

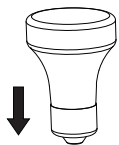

**2** SCREW BULBS INTO SOCKETS

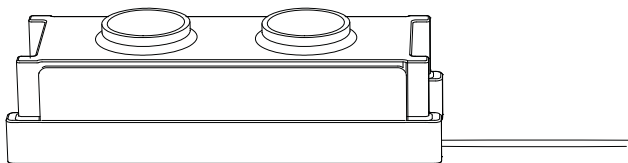

## ASSEMBLY

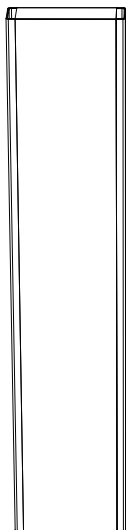

**3** PRESS FIT SHADE OVER BASE AS SHOWN

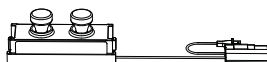

Pablo®

# CORTINA

INFO@PABLODESIGNS.COM  
888 MARIN STREET  
SAN FRANCISCO, CA  
94124

PABLODESIGNS.COM